

Laboratory and Field Validation of a Wireless Sensing Unit Design for Structural Monitoring

Jerome Peter Lynch¹, Kincho H. Law², Anne S. Kiremidjian², Ed Carryer³
The John A. Blume Earthquake Engineering Center, Stanford University, Stanford, CA 94305

Charles R. Farrar⁴, Hoon Sohn⁴, David Allen⁴, Brett Nadler⁴, Jeannette Wait⁴
Los Alamos National Laboratory, Los Alamos, NM 87545 USA

ABSTRACT

There exists a clear need to monitor the performance of civil structures over their operational lives. Current commercial monitoring systems suffer from various technological and economic limitations that prevent widespread adoption. The wires used to route measurements from system sensors to the centralized data server represent one of the greatest limitations since they are physically vulnerable and expensive from an installation and maintenance standpoint. In lieu of cables, the introduction of low-cost wireless communications is proposed. The result is the design of a prototype wireless sensing unit that can serve as the fundamental building block of wireless modular monitoring systems (WiMMS). The prototype unit is validated with a series of tests conducted in the laboratory and the field. In particular, the Alamosa Canyon Bridge is employed to serve as a full-scale benchmark structure to validate the performance of the wireless sensing unit in the field.

INTRODUCTION

The installation of structural monitoring systems in civil structures entails the spatial distribution of embedded sensors to measure structural responses to environmental loads. Historically, structural monitoring systems have been used to monitor strong ground motions and

¹ PhD Candidate, correspondence can be sent to: jplynch@stanford.edu

² Professor of Civil and Environmental Engineering

³ Professor (Consulting) of Mechanical Engineering

⁴ Technical Staff Member

their effect on structures leading to improvements in the design of structures in zones of high seismicity (Shakal 2001). Today, additional benefits are derived from installing structural monitoring systems in a variety of structures. For example, monitoring systems are extensively used to track the long-term performance of a structure, to help calibrate nonlinear analytical models, and to monitor top-story displacements of structures adjacent to large excavations.

In the future, structural monitoring systems will become increasingly popular for a broader set of applications. In particular, monitoring systems will serve as the necessary infrastructure for automated structural health monitoring systems. Rapid advancements made in the field of damage detection are yielding algorithms capable of using structural response measurements to identify the existence, location and type of damage present in a structural system (Doebbling et al. 1996). Methods are becoming more reliable in detecting the onset of damage, particularly in civil structures where environmental and operational variability often mask evidence of damage (Sohn et al. 1999). The coupling of a structural monitoring system and damage detection methods results in a structural health monitoring system. Many benefits are associated with an automated structural health monitoring system including cost-effective condition-based maintenance being used in lieu of the current schedule-based maintenance paradigm.

Wire-based monitoring systems suffer many economic and technological limitations. The current cost of installing monitoring systems in civil structures is high. For example, the cost of installing a monitoring system in the Tsing Ma suspension bridge was reported over \$27,000 per sensing channel (Farrar 2001). The expensive nature of structural monitoring systems is a direct result of the wires used to communicate sensor measurements to the centralized data server. Over 75% of the installation time is attributable to the laying of wires in a structure with installation costs representing up to 25% of the total system cost (Straser and Kiremidjian 1998). Installation efforts and costs can increase for structures with difficult to reach locations through which wires must be installed. Wires also represent a fragile component of current monitoring systems. Tearing of wires and rodent nibbling are common occurrences necessitating vigilant maintenance efforts on the part of system owners.

Current commercial monitoring systems employ hub-spoke system architectures with remote sensors wired directly to a centralized data acquisition server. The tasks of aggregating, storing, and interrogating the measurement data are assumed by the centralized server. A limitation of current monitoring systems' architectures is the centralized data server. Being a single point of possible failure in the system, the central server can become overburdened as system size grows and computation demands increase. As a result, if the centralized system architecture is used for structural health monitoring applications, careful attention must be paid to the implementation of damage detection methods to ensure the computational capabilities of the server are not saturated.

In response to the identified limitations of current state-of-practice systems, a novel monitoring paradigm is proposed: wireless structural monitoring (Straser and Kiremidjian 1998, Lynch et al. 2002a). Identifying wires as a severe limitation of tethered monitoring systems, the incorporation of wireless communications is proposed for the transfer of measurement data in a wireless monitoring system. The past decade has witnessed a revolution in wireless communication technologies with capabilities improving and costs continuously reducing. As a result, wireless communications can serve as a reliable substitute to wires at a fraction of their associated costs. A second innovation is proposed; integrate computational power for local processing of measurement data with each sensing node of the system (Lynch et al. 2002b). By providing each sensor the means to process its own data, computational burden is removed from

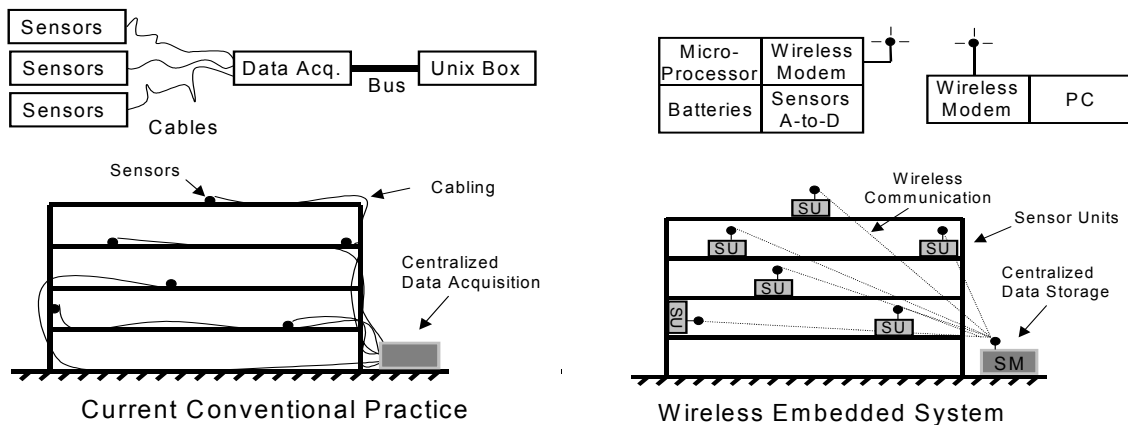

Figure 1 – Wire-based versus wireless structural monitoring systems

the centralized server in addition to many benefits associated with parallel data processing reaped.

The innovations of the proposed wireless monitoring system are embodied by the design of a wireless sensing unit that is constructed from advanced embedded system and wireless technologies (Lynch 2002). Wireless sensing units represent the fundamental building block of wireless modular monitoring systems (WiMMS), as illustrated in Fig. 1. The unit design is optimized for application in civil structures with a heavy emphasis placed upon keeping the total unit cost low. Damage detection methods, as they mature, will be embedded in the wireless sensing unit to deliver a low-cost automated structural health monitoring system.

This paper explores the design of a prototype wireless sensing unit for WiMMS deployment. After the wireless sensing unit is fabricated, a series of tests are performed in the laboratory and field to validate its performance. The focus of the laboratory validation tests is to explore the interfacing of different sensing transducers with the wireless sensing unit. The Alamosa Canyon Bridge is selected to serve as a benchmark structure for field validation. A classical cable-based monitoring system is installed in parallel in the bridge to facilitate a comparison of the performance for the wireless and the wired system. For illustration of the local data processing capabilities of the wireless sensing unit design, a fast Fourier transform (FFT) algorithm is selected for embedment. The wireless sensing unit uses the FFT to convert recorded measurement time histories to their frequency response functions.

HARDWARE DESIGN OF WIRELESS SENSING UNIT

As the enabling building block of an automated structural health monitoring system, careful attention is paid to the design of the wireless sensing unit. A modular design with off-the-shelf components is employed to keep fabrication efforts reasonable and total unit costs low. The architectural design of the wireless sensing unit, as shown in Fig. 2, is divided into three major subsystems: sensor interface, computational core, and wireless communications.

The first subsystem, the sensing interface, is responsible for the interfacing of various sensing transducers (e.g. accelerometers, strain gages, and anemometers) that will provide

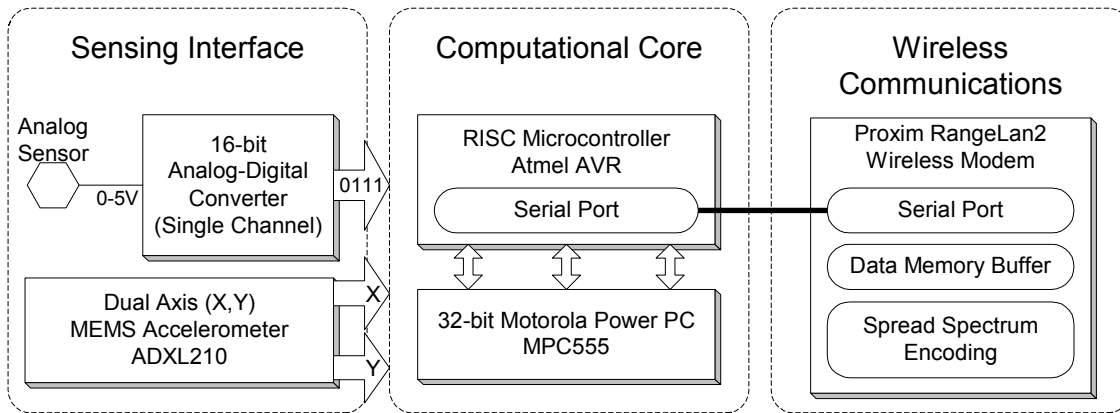

Figure 2 – Architectural design schematic of proposed wireless sensing unit

measurements of environmental loads and responses of the structure. To accommodate multiple sensors simultaneously, a multi-channel interface is designed. At the core of the sensing interface subsystem is a single-channel analog-to-digital (A/D) converter that can resolve the output of any analog sensor to a 16-bit digital representation. Sampling rates as high as 100 kHz can be attained using the Texas Instruments ADS7821 16-bit A/D converter. Two additional sensing channels are provided that accept duty cycle modulated outputs from a wide class of digital sensors. Many commercial MEMS-based accelerometers provide duty cycle modulated outputs with resolutions of 14-bits (Analog Devices 1999).

After measurement data is collected by the sensing interface, it is read by the computational core of the wireless sensing unit. At the center of the unit's architectural design, the computational core is responsible for aggregating measurement data from the sensing interface, executing data interrogation tasks, and transferring data through the wireless modem to a wireless network comprised of wireless sensing units. A two processor core design is employed with a low power 8-bit microcontroller chosen for simple unit operation and a powerful 32-bit microcontroller dedicated to performing data interrogation tasks. The 8-bit Atmel AT90S8515 AVR microcontroller is selected for its capability-rich hardware design, low cost and efficient power characteristics. For the execution of computationally demanding data interrogation algorithms, the 32-bit Motorola MPC555 PowerPC microcontroller is selected. With 448 Kbytes of flash ROM and 26 Kbytes of RAM, sufficient on-board memory is provided to serve as storage of measurement data. Special data registers are provided by the MPC555 to perform rapid floating-point calculations in hardware.

Wireless communications is an important ingredient in the sensing unit design to ensure low system costs and modular installation features. The Proxim RangeLAN2 radio modem is chosen to serve as a reliable wireless communication technology of the wireless sensing unit. Operating on the 2.4 GHz unregulated FCC industrial, scientific and medical (ISM) band, data rates of 1.6 Mbps can be attained with communication ranges of up to 350 meters in unobstructed open space. Within structures constructed from heavy construction materials (e.g. concrete), the communication range reduces to about 160 meters. To ensure reliable wireless communication, data packets are modulated using frequency-hopping spread spectrum (FHSS) techniques.

The selected components of the wireless sensing unit are assembled into a single package. A two-layer printed circuit board is designed to house the components and their support circuitries. Careful attention is paid during the design of the circuit to prevent the injection of electrical

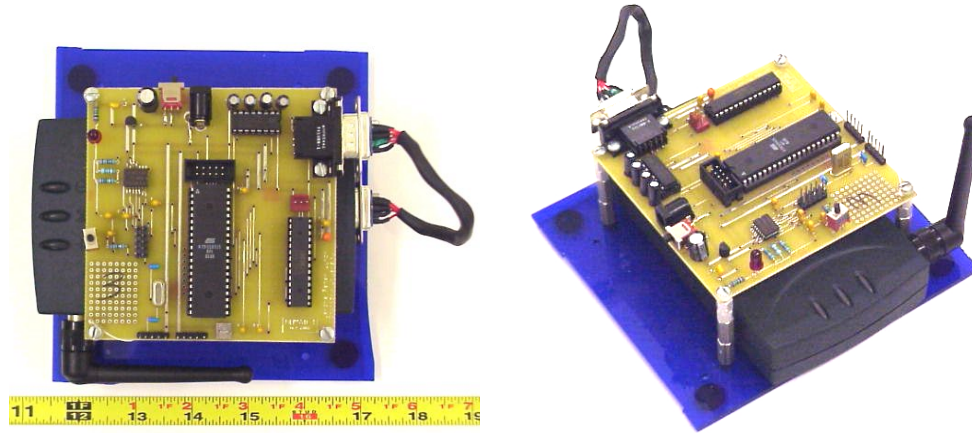

Figure 3 – Top and perspective view of prototype wireless sensing unit

noise that can result from a poor circuit board layout (Ginsberg 1990). Roughly 10 cm by 10 cm, the printed circuit board is sufficiently compact, and is powered by a direct current (DC) 7.5 V power source. The RangeLAN2 radio modem is kept in its original packaging and is not included in the printed circuit board design. The radio is attached to the wireless sensing unit through a serial port. Fig. 3 shows a picture of the completed prototype wireless sensing unit. The printed circuit board is packaged at the top of the unit and the wireless modem housed beneath.

LABORATORY DATA ACQUISITION VALIDATION

Validation of the wireless sensing unit is first performed in the laboratory. The laboratory setting provides a stable environment ideal for testing the prototype. The wireless sensing unit is installed in a simple test structure to measure its response to external disturbances. While a variety of sensing transducers can be interfaced to the wireless sensing unit, accelerometers are used in this study.

A wide variety of accelerometer types with different performance characteristics are commercially available. For structural monitoring applications, the force balance accelerometer is most popular due to its accuracy and high-level output (Kinematics 2002). Most recently, micro-electro mechanical system (MEMS) researchers have fabricated in silicon dies sensing transducers on the micrometer scale. The result is sensing transducers integrated with digital circuitry to yield low cost yet highly accurate sensors with small form factors. In particular, accelerometers have been beneficiaries of these developments with MEMS-based accelerometers of different internal architectures readily available. In this study, the Analog Devices ADXL210 accelerometer is considered for integration with the wireless sensing unit. The ADXL210 is a MEMS-based accelerometer employing a differential capacitor internal architecture that is capable of measuring accelerations of ± 10 g. The bandwidth and noise floor of the accelerometer are adjustable with smaller bandwidths resulting in lower noise floors. A bandwidth of 50 Hz is selected resulting in an RMS resolution (noise floor) of 4.33 mg. The accelerometer sensitivity is fixed at 100 mV/g.

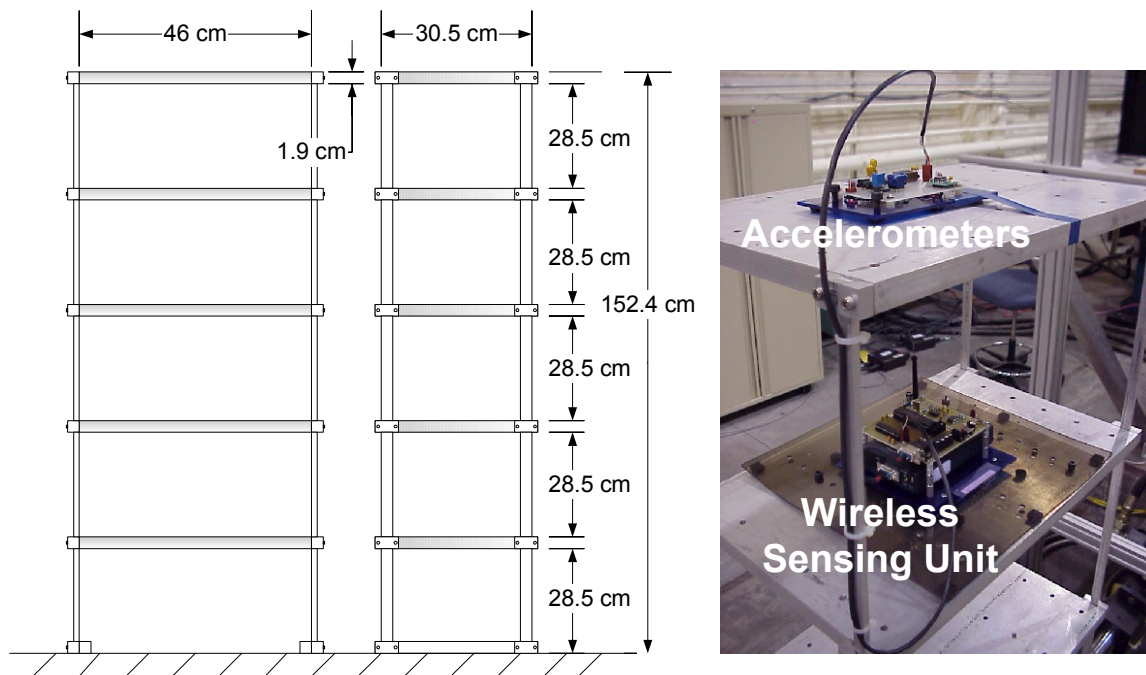

Figure 4 – Test structure for laboratory validation of the prototype wireless sensing unit

To validate the performance of the wireless sensing unit with an ADXL210 accelerometer interfaced, a five degree-of-freedom test structure mounted to an 11-kip shaking table is utilized. The aluminum structure behaves as a shear structure because the structure's floors are constructed with rigid aluminum plates. The ADXL210 accelerometer is mounted to the top story of the structure to measure absolute acceleration responses. The wireless sensing unit is attached to the fourth story. The dimensions of the test structure are illustrated in Fig. 4.

First, from log decrement calculations of the structure's free vibration response, structural damping is estimated to be 0.5% of critical damping. Next, a sweep sine signal of constant displacement amplitude (0.2 cm) and linearly varying frequency (0.25 to 3 Hz over 60 seconds) is applied by the shaking table. During the excitation, the absolute acceleration response at the top story is recorded by the wireless sensing unit at a sampling rate of 30 Hz. Fig. 5 presents the measured absolute acceleration response of the structure and the theoretical response determined from an analytical model of the structure. The measured absolute acceleration response is in good agreement with that obtained for the theoretical model.

The frequency response function of the recorded time history is calculated by the wireless sensing unit using an embedded FFT algorithm. The FFT is performed on 1024 consecutive time points of the response from 10 to 44 seconds. The first three modes of response of the test structure can be visually identified from the response function of Fig. 6. The first three modes are identified at 2.87, 8.59, and 13.54 Hz. The identified modal frequencies are within 3% of those analytically calculated from the theoretical model at 2.96, 8.71 and 13.70 Hz.

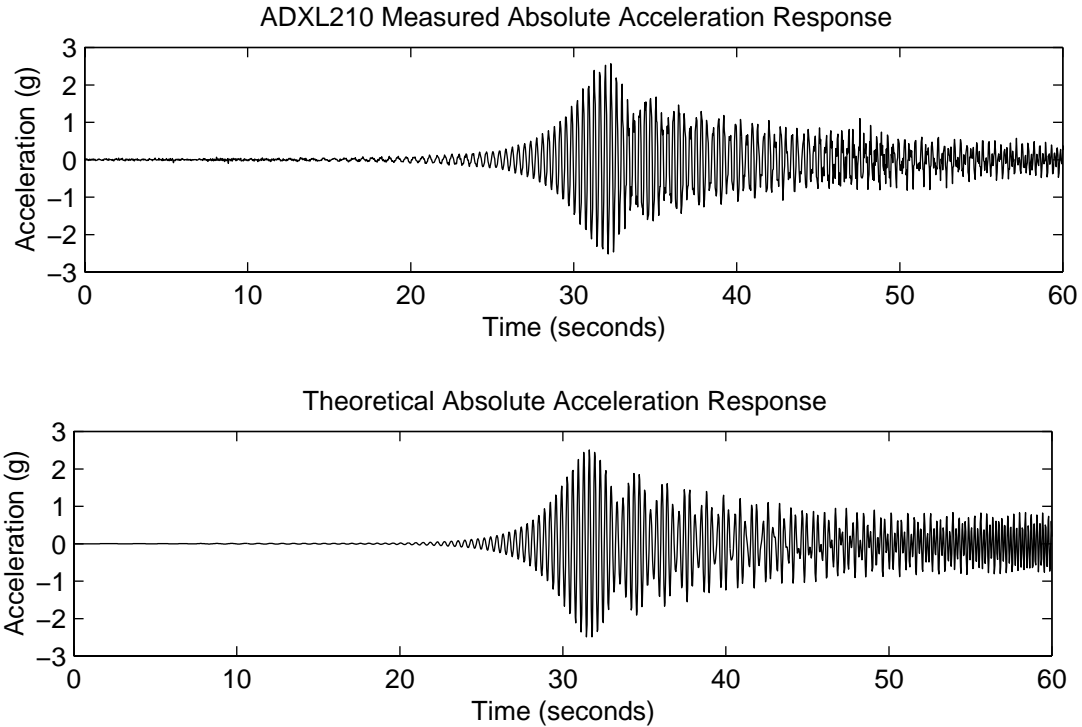

Figure 5 – Actual measured (top) and theoretical (bottom) absolute acceleration response of the test structure

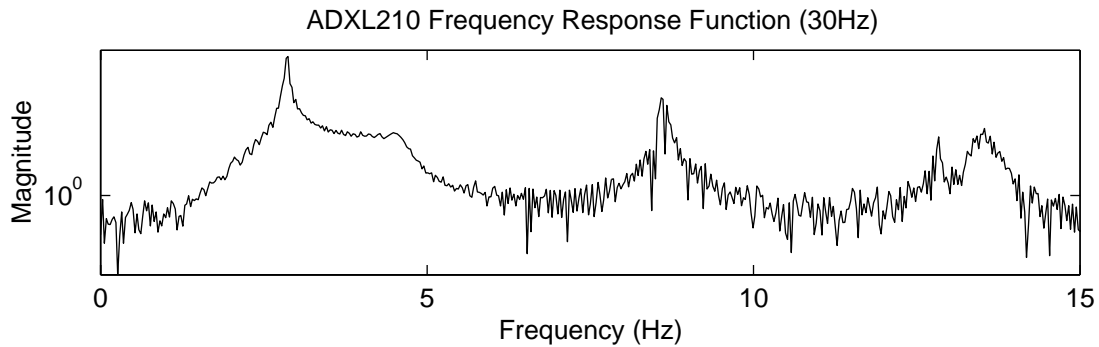

Figure 6 – Frequency response function of five-story test structure

FIELD DEPLOYMENT – ALAMOSA CANYON BRIDGE

The Alamosa Canyon Bridge located in Truth or Consequences, New Mexico, is selected to serve as the benchmark structure for field validation of the wireless sensing unit. Constructed in 1937, the bridge is comprised of seven simply supported spans, each 15.2 m in length and 7.3 m wide. Each span is comprised of six W30 x 116 steel girders, spaced 1.47 m apart, supporting an 18 cm thick concrete deck. A more detailed description of the Alamosa Canyon Bridge is presented in Fig. 7. The bridge and its modal properties have been documented in detail from previous benchmark studies (Farrar et al. 1997).

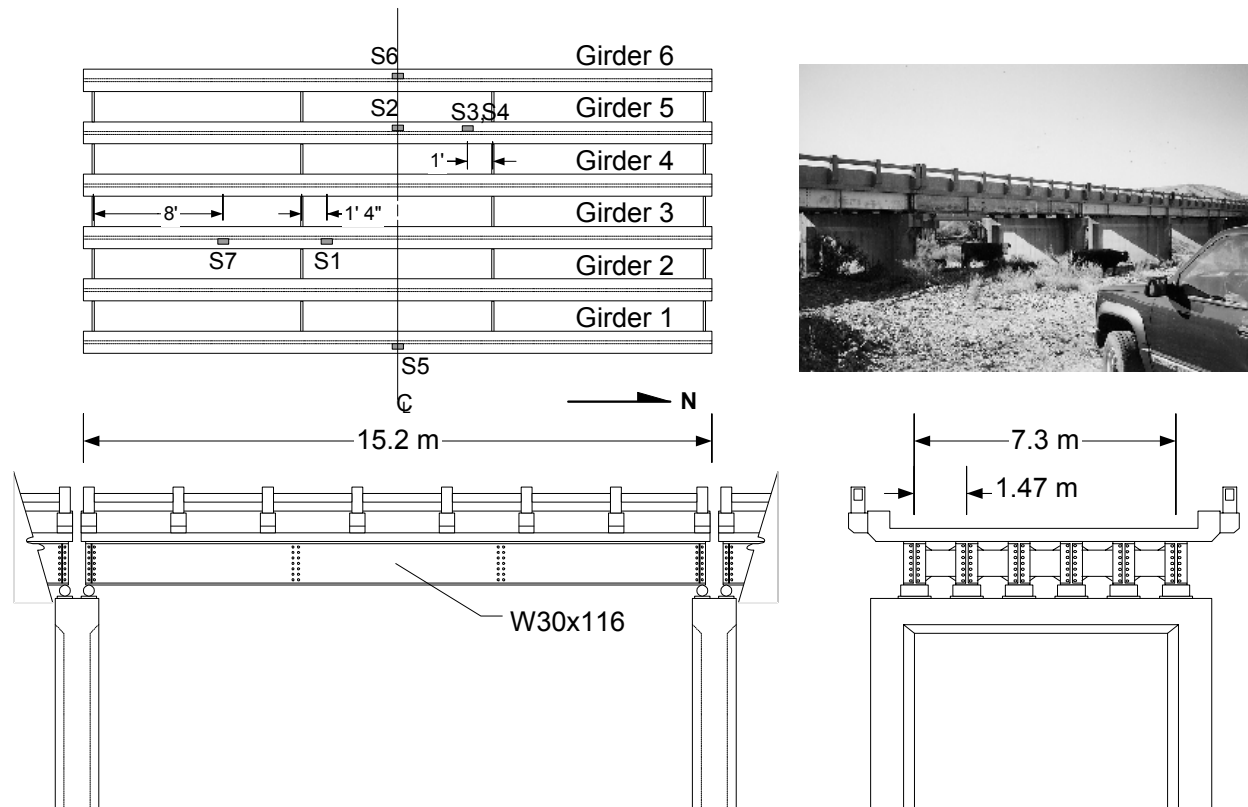

Figure 7 – Field validation structure – Alamosa Canyon Bridge, NM, USA

The goal of the field validation tests is to compare the performance of the prototype wireless sensing unit to that of a commercial cable-based structural monitoring system. The commercial data acquisition system selected is the Dactron SpectraBook dynamic signal analyzer. The SpectraBook can accommodate 8 simultaneous input channels with sampling rates as high as 21 kHz. Analog sensors interfaced to the system are converted to 24-bit digital representations. A wireless monitoring system is installed adjacent to the Dactron system with wireless sensing units placed at sensor locations throughout the structure (marked as S1 to S7 in Fig. 7).

Two different accelerometers are employed for installation in the Alamosa Canyon Bridge to measure a broad set of ambient and forced vibrations. The first accelerometer, the Piezotronics PCB336C, is used with the Dactron system. The piezoelectric internal architecture of the PCB336C is capable of measuring acceleration responses in the 1 to 2000 Hz frequency and $\pm 4g$ amplitude ranges. The accelerometer is well suited for measuring low acceleration response because its noise floor is 60 μg and its sensitivity is high at 1 V/g. Interfaced to the wireless sensing unit is a MEMS-based capacitive accelerometer, the $\pm 1 g$ Crossbow CXL01LF1. The CXL01LF1 is also well suited for low amplitude response measurements because of its 2 V/g sensitivity and 500 μg noise floor. The noise floor of the CXL01LF1 represents a 90% reduction compared to that of the ADXL210 (4.33 mg). Both accelerometers are epoxy mounted at the girder's midpoint at the locations noted in Fig. 7.

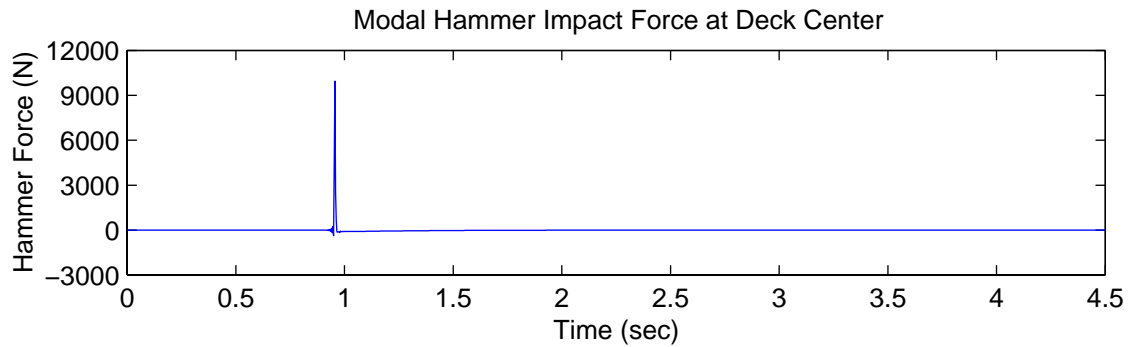

Figure 8 – Recorded impact load from modal hammer

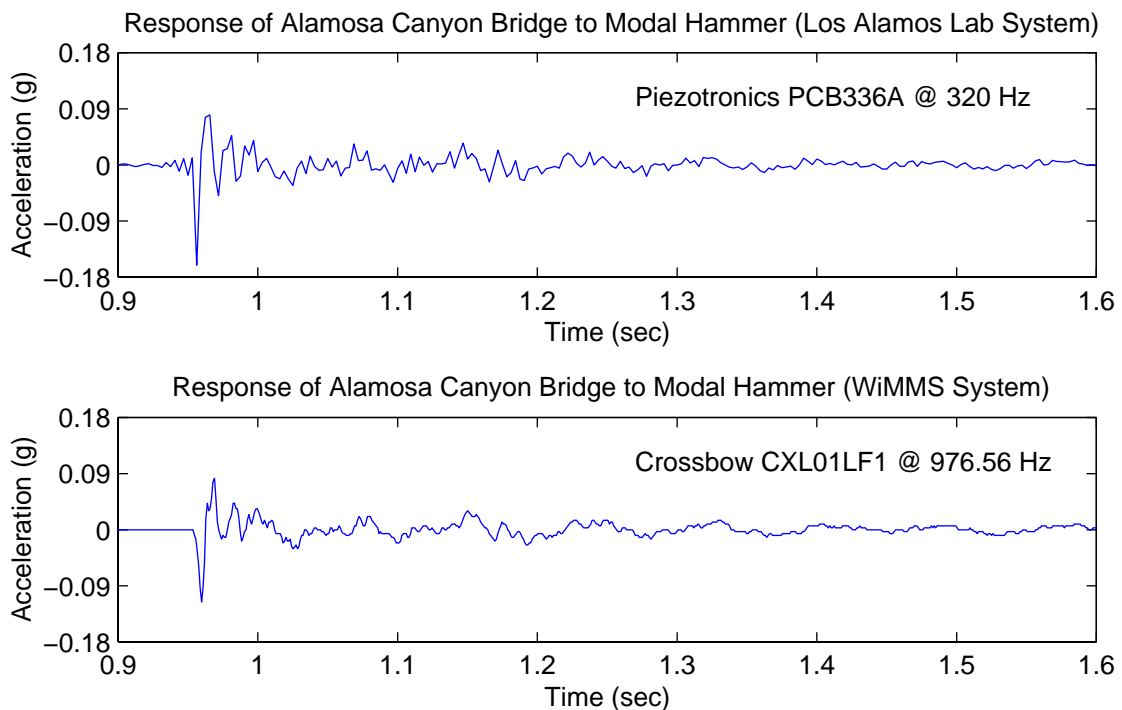

Figure 9 – Acceleration response at S3 measured by the PCB336 (top) and CXL01LF1 (bottom) accelerometers

A modal hammer is used to deliver an impact load to the bridge’s deck. The PCB86C50 modal hammer is selected. The tip of the hammer contains a load cell that is capable of recording the time-history of the delivered loading to the structure. One valuable feature of the excitation delivered by the modal hammer is that it is a nearly perfect impulse load.

The load delivered by the modal hammer blow is shown in Fig. 8. The response to the excitation is measured by the accelerometers mounted at sensor location S3 and recorded by the Dacton system and the wireless sensing unit. The acceleration response of the Alamosa Canyon Bridge is presented in Fig. 9 as measured by both data acquisition systems. The Dacton system measures the response at a sampling rate of 320 Hz while the wireless sensing unit is configured to record the response at 976 Hz.

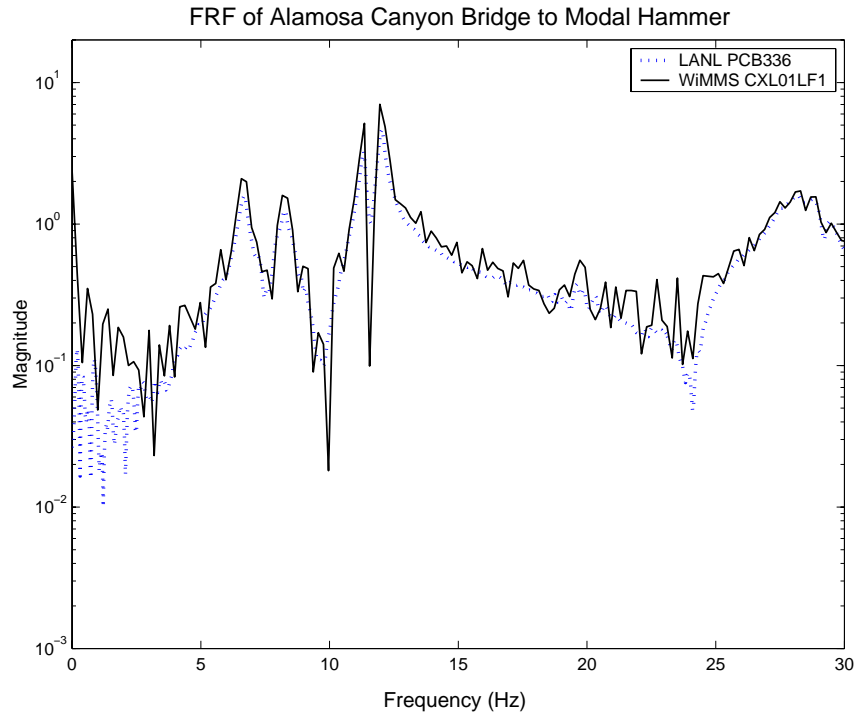

Figure 10 – Frequency response function of the measured acceleration at S3

In comparing the measured acceleration response of the Alamosa Canyon Bridge to the same modal hammer impact force, strong agreement in both amplitude and time is evident. Minor discrepancies exist in the initial peak measured by the two systems with the Dactron system measuring a peak of 0.17 g and the wireless sensing unit peak amplitude at roughly 0.12 g. Subsequent peaks after the initial peak are in complete agreement with each other. These results indicate the reliability and accuracy of the prototype wireless sensing unit.

The modal impact test is repeated numerous times to measure acceleration at the other sensor locations indicated in Fig. 7. In total, 14 acceleration time-history records are obtained (7 from the wireless sensing units and 7 generated by the Dactron system). For the other sensor locations, results similar to those found at sensor location S3 are obtained with strong agreement in the response measured by the two systems.

To assist in identifying the primary modal frequencies of the bridge, the frequency response function of the system is determined by the wireless sensing unit from the time-history response measured at S3. The frequency response function is also determined by the Dactron system using RT Signal Pro, a modal analysis software package. The frequency response function calculated by both systems from measurements obtained at sensor location S3 are presented in Fig. 10. The FFT performed by the Dactron system measurements was an 8192 point analysis. With memory limited on the wireless sensing unit, only 5000 data points could be stored. As a result, the FFT performed by the wireless unit was a 4096 point analysis.

Strong agreement exists in the two frequency response functions, particularly, with the peaks of the function in alignment. Some differences are present at the very low frequencies due to the DC limitations of the piezoelectric architecture of the PCB336C accelerometer. Three modes

of response are immediately evident from the frequency response function at 6.7, 8.2 and 11.4 Hz. Previous published modal analysis results of a different span of the Alamosa Canyon Bridge indicate that the first four modes are located at 7.3, 8.0, 11.7 and 20.2 Hz (Farrar et al. 1997). The difference between the identified mode frequencies are less than 9% and can be attributed to subtle structural differences that exist between the two different spans instrumented.

CONCLUSION

The design of an advanced wireless sensing unit, capable of deployment in wireless modular monitoring systems (WiMMS), has been presented. With the advanced embedded system technologies integrated, a low cost yet computationally capable design has been achieved. In particular, a RangeLAN2 wireless modem was employed for peer-to-peer transfer of measurement data. A dual microcontroller design was pursued with a low-power 8-bit microcontroller responsible for simple data acquisition tasks and a second 32-bit microcontroller used for implementation of demanding numerical algorithms.

After the design was completed and prototype units fabricated, a series of validation tests were performed to ensure adequate performance was attained. First, the laboratory setting was exploited to interface a MEMS-based accelerometer to the wireless sensing unit. The measured response of a laboratory test structure using the MEMS accelerometer was nearly identical to that predicted using a theoretical model of the structure. The frequency response function of the structure was derived by the wireless sensing unit from the measured data. Modes identified from the derived frequency response function were within 3% of those theoretically predicted.

With the wireless sensing unit validated in the laboratory, the units were taken to the field for installation in the Alamosa Canyon Bridge. A traditional tethered monitoring system was installed in parallel to the wireless monitoring system comprised of wireless sensing units. Forced vibrations were induced in the structural system using a modal hammer with the absolute acceleration response of the bridge recorded. Post-processing of the recorded response was performed using an FFT to derive the frequency response function of the structure. In comparison to the wire-based data acquisition system, the wireless system performed nearly as well at a fraction of the tethered system cost. Furthermore, the installation time of the wireless system was less than a third of the cable-based Dactron system.

Future improvements can be made to the current wireless sensing unit design. Immediately evident was a need for improved A/D converter resolution and increased memory for the storage of temporary measurement data. As the embedded system market evolves, new and innovative technologies that emerge should be considered for inclusion in the wireless sensing unit to broaden its capabilities while reducing costs. With respect to embedded application software, more work is needed to explore the integration of data interrogation schemes such as those that perform damage detection analysis.

ACKNOWLEDGEMENTS

This research is partially sponsored by the National Science Foundation, Grant Numbers CMS-9988909 and CMS-0121842. The experiment of the Alamosa Canyon Bridge was supported by Los Alamos Laboratory Directed Research and Development (LDRD) fund.

REFERENCES

- Analog Devices, Inc. (1999). *ADXL202/ADXL210 data sheet – low cost 2g/10g dual axis iMEMS accelerometers with digital outputs*. Norwood, MA.
- Doebling, S. W., Farrar, C. R., Prime, M. B., and Shevitz, D. W. (1996). *Damage identification and health monitoring of structural and mechanical systems from changes in their vibration characteristics: a literature review*. Report No. LA-13070-MS, Los Alamos National Laboratory, Los Alamos, NM.
- Farrar, C. R., Doebling, S. W., Cornwell, P. J., and Straser, E. G. (1997). “Variability of modal parameters measured on the Alamosa Canyon Bridge.” *Proceedings of the 15th International Modal Analysis Conference*, Society of Engineering Mechanics, Bethel, CT, pp. 257-263.
- Farrar, C. R. (2001). “Historical overview of structural health monitoring.” *Lecture Notes on Structural Health Monitoring using Statistical Pattern Recognition*. Los Alamos Dynamics, Los Alamos, NM.
- Ginsberg, G. L. (1990). *Printed circuit design featuring computer-aided technologies*. McGraw-Hill Inc., New York, NY.
- Kinematics, Inc. (2002). *ALTUS – Earthquake monitoring instruments and systems*. Pasadena, CA.
- Lynch, J. P. (2002). *Decentralization of wireless monitoring and control technologies for smart civil structures*. Ph.D. Thesis, Department of Civil and Environmental Engineering, Stanford University, Stanford, CA.
- Lynch, J. P., Law, K. H., Kiremidjian, A. S., Carryer, E., Kenny, T. W., Partridge, A., and Sundararajan, A. (2002a). “Validation of a wireless modular monitoring system for structures.” *Proceedings of Smart Structures and Materials*, SPIE, San Diego, CA (in press).
- Lynch, J. P., Sundararajan, A., Law, K. H., and Kiremidjian, A. S. (2002b). “Embedding algorithms in a wireless structural monitoring system.” *Proceedings of the International Conference on Advances and New Challenges in Earthquake Engineering Research*, Hong Kong Polytechnic University, Hong Kong, China (in press).
- Shakal, A. F. (2001). “Utilization of instrumental measurements in diagnostics for seismic response.” *Proceedings of Instrumental Systems for Diagnostics of Seismic Response of Bridges and Dams*, Consortium of Organizations for Strong-Motion Observation Systems, Richmond, CA, pp. 21-22.
- Sohn, H., Dzwonczyk, M., Straser, E. G., Kiremidjian, A. S., Law, K. H., and Meng, T. (1999). “An experimental study of temperature effect on modal parameters of the Alamosa Canyon Bridge.” *Earthquake Engineering and Structural Dynamics*, John Wiley & Sons, 28(9) : 879-897.
- Straser, E. G., and Kiremidjian, A. S. (1998). *A modular, wireless damage monitoring system for structures*. Report No. 128, John A. Blume Earthquake Engineering Center, Department of Civil and Environmental Engineering, Stanford University, Stanford, CA.